



2009

COMBINAZIONI FINITURE COLORE PER L'IDENTIFICAZIONE DEL CODICE / COMPLETARE IL CODICE ARTICOLO CON IL CODICE COLORE
 Combinations of finishes and colours for code identification / Complete the article with the colour code
 Combinaisons finitions couleur pour l'identification de la couleur / Compléter le code article avec le code couleur
 Farbenzusammenstellung zur Ausführung-Identifizierung / Art.-Nr. immer mit Farbcode ergänzen
 Combinación de acabados y colores para identificación de códigos / Completar el código con la referencia acabado

126.116. 0

TAVOLI SCRIVANIA Tables and desk Tables et bureau Tische und Schreibtisch Mesas y escritorio

	struttura structure structure Struktur estructura	piani tops plateaux Platten tableros	muretto type-wall muret Wangenverlängerung muro	
				034
				035
				027

ACCESSORI Accessories Accessoires Zubehör Accesorios

	050		059		000
--	-----	--	-----	--	-----

CASSETTIERE E MOBILETTI DI SERVIZIO SU RUOTE

Drawer units Caissons Schubladenelemente Cajoneras

	034		035		027
--	-----	--	-----	--	-----

CONTENITORI Cabinets Armoires Schränke Contenedores

struttura structure structure Struktur estructura	top/anta top/door dessus/porte Abdeckplatte/Holztür plano/puerta	ante vetro glass doors portes vitrées Glastüren puertas en cristal		
	+		+	034 055 155
	+		+	035 077 177
	+		+	027 095 195

melo apple wood pommier Apfelbaum manzano	noce walnut noyer Nussbaum nogal	wengé	alluminio aluminium aluminium aluminio	nero black noir schwarz negro	vetro fumé' smoked glass verre fumé Glastüren verdunkelt cristal fumé
					vetro temperato acidato / telaio alluminio satin tempered glass / aluminium frame verre traitées à l'acide / encadrement aluminium gehaertete glastüren / rahmen aluminium cristal opaco templado / perfil aluminio

PIANO TAVOLI E SCRIVANIE

in truciolare melaminico antimacchia e antigraffio
 spessore 38 mm - bordo ABS 2 mm laterale - colore melo, noce, wengé
TOP FOR TABLES AND DESKS
 in stainproof and antiscratch melamine chipboard
 thickness 38 mm - edge ABS 2 mm lateral sides
 colour apple-wood, walnut, wengé

PLATEAU TABLES ET BUREAUX

matériel en bois aggloméré mélaminé anti-taches et anti-rayures
 épaisseur 38 mm - chants ABS 2 mm - coloris pommier, noyer, wengé
TISCH- U. SCHREIBTISCHPLATTEN

kratzfeste bzw. Fleckenabweisender Melaminbeschichteter Spanplatte
 Stärke 38 mm - Kante ABS 2 mm - Farbe Apfelbaum, Nussbaum, wengé

TABLEROS MESAS Y ESCRITORIOS

aglomerado de madera revestido de melamina
 resistente a manchas y al rayado
 espesor 38 mm - canto ABS 2 mm color manzano, nogal, wengé

	melo apple wood pommier Apfelbaum manzano		noce walnut noyer Nussbaum nogal		wengé
--	-------------------------------------------------------	--	----------------------------------------------	--	-------

STRUTTURA

Gamba e modesty panel truciolare melaminico
 antimacchia e antigraffio
 spessore 38 - 18 mm - colore melo, noce, wengé
Distanziale in lamiera verniciata H 40 mm colore alluminio
Piedino in ABS regolabile colore alluminio

STRUCTURE

Leg and modesty panel stainproof and antiscratch
 melamine chipboard thickness 38 - 18 mm
 colour apple-wood, walnut, wengé
Catcher metal sheet H 40 mm aluminium colour
Foot in ABS adjustable colour aluminium

STRUCTURE

Pied et Voile de fond bois aggloméré mélaminé
 anti-taches et anti-rayures épaisseur 38 / 18 mm
 coloris pommier, noyer, wengé - chants ABS 2 mm
Entretoise tôle 40/10 peinture
 à poudres époxydiques H 40 mm coloris aluminium
Vérin de réglage en ABS coloris aluminium

KORPUS

Seitenwange und Knieblende kratzfeste bzw. Fleckenabweisender
 Melaminbeschichteter Spanplatte
 Stärke 38 / 18 mm - Farbe Apfelbaum, Nussbaum, Wengé
 Kante ABS 2 mm

Abstandhalter Aus blech 40/10 mm

Epoxydpuilverbeschichtet - H. 40 mm Farbe Alu

Fuß ABS, einstellbar, alufarbig

ESTRUCTURA

Pata y Faldón aglomerado de madera revestido de melamina
 resistente a manchas y al rayado - espesor 38 / 10 mm
 color manzano, nogal, wengé - canto ABS 2 mm

Distanciadores chapa 40/10 barnizada al epoxy
 H 40 mm color aluminio

Pie regulable en ABS color aluminio

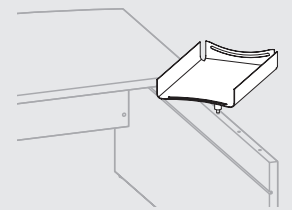

VASCHETTA PORTA CARTE
PAPER HOLDER
PORTE-PAPIER
PAPIERHALTER
BANDEJA CORRESPONDENCIA

LAMPADA "Tolomeo" di Artemide ad incandescenza max 100W
 classe II versione Italia - supporto in acciaio tornito

LAMP "Tolomeo" by Artemide Incandescence lamp max 100W
 II class, italian version - Turned steel support

LAMPE "Tolomeo" de Artemide
 à incandescence max 100 W
 calssse II versione Italie - support en acier tourné

LAMPE "Tolomeo" von Artemide

LÁMPARA "Tolomeo" by Atermide

con incandescencia max 100 W clase II versione Italia

apoyo en acero

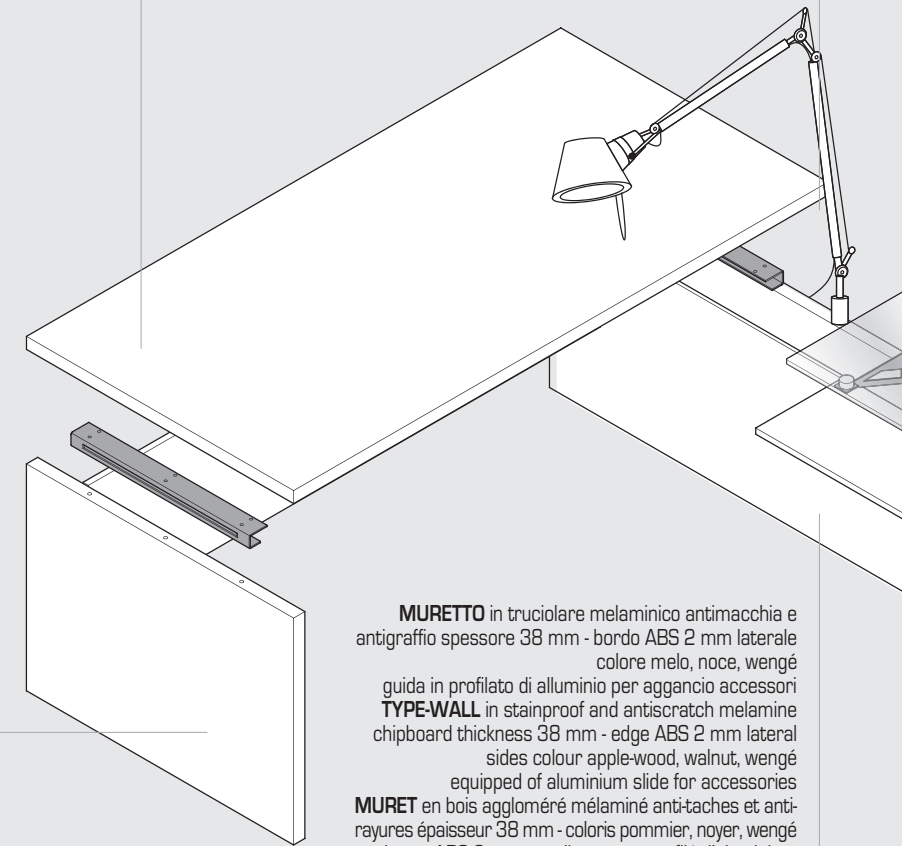

MURETTO in truciolare melaminico antimacchia e
 antigraffio spessore 38 mm - bordo ABS 2 mm laterale
 colore melo, noce, wengé

guida in profilato di alluminio per aggancio accessori
TYPE-WALL in stainproof and antiscratch melamine
 chipboard thickness 38 mm - edge ABS 2 mm lateral
 sides colour apple-wood, walnut, wengé

equipped of aluminium slide for accessories
MURET en bois aggloméré mélaminé anti-taches et anti-
 rayures épaisseur 38 mm - coloris pommier, noyer, wengé
 chants ABS 2 mm - coulisseau en profilé d'aluminium

pour accrochage accessoires
LANGE SEITENWANGE

kratzfeste bzw. Fleckenabweisender Melaminbeschichteter
 Spanplatte Stärke 38 mm Farbe Apfelbaum, Nussbaum,
 Wengé - Kante ABS 2 mm Befestigungsschiene
 Eingearbeitete Alu-Schiene zur Aufnahme v. versch.

Zubehör-Elemente
MURO en aglomerado de madera revestido de melamina
 resistente a manchas y al rayado espesor 38 mm
 color manzano, nogal, wengé - canto ABS 2 mm
 perfil en aluminio para colgar accesorios

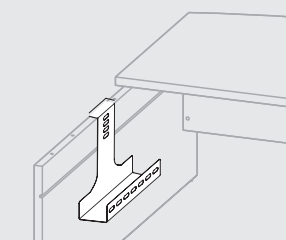

PORTA CPU lamiera stampata colore alluminio
CPU HOLDER moulded metal sheet aluminium colour
SUPPORT POUR UNITÉ CENTRALE
 en tôle coloris aluminium
CPU-TRÄGER aus Metall Alufarbig
PORTA ORDENADOR en metal color aluminio

**CASSETTIERA SU RUOTE**

Struttura e frontale cassetto in truciolare melaminico antimacchia e antigraffio spessore 18 mm **top** spessore 25 mm **Colore** melo, noce, wengé **Serratura** di serie con bloccaggio simultaneo di tutti i cassetti - chiave snodabile **Ruota** in ABS nero piroettante **Maniglia** in metallo
DRAWER UNITS ON CASTORS
Structure and Frontal drawer in antiscratch and stainproof melamine chipboard Thickness 18 mm **top** Thickness 25 mm **Colour** apple wood, walnut, wengé **Lock** standard, with simultaneous locking of all drawers **Castor** black ABS pirouetting **Metal** handle

MENSOLA in vetro temperato acidato spessore 12 mm supporti in metallo colore alluminio
SHELF in tempered satin glass 12 mm thickness aluminium colour metal supports
ÉTAGÈRE vitrée traitée à l'acide, épaisseur 12 mm, supports en métal coloris aluminium
GLASABLAGE aus gehärtetes bzw. geätztes Glas, 12 mm stark u. Alufarbige Metallbefestigungselemente
ESTANTE en cristal temprado al acido, espesor 12 mm soportes en metal color aluminio

MENSOLA PENSILE in truciolare melaminico antimacchia, antigraffio Spessore 18 mm Colore Melo, noce, wengé
SUSPENDED SHELF anti-scratch and stain-proof melamine chipboard thickness 18 mm colour apple-wood, walnut, wengé
ÉTAGÈRES en bois aggloméré mélaminé anti-taches et anti-rayures épaisseur 18 mm, Coloris pommier, noyer, wengé
ABLAGEN aus kratzfester bzw. Fleckenabweisender Melaminbeschichteter Spanplatte, 18 mm stark, Farbe Apfelbaum, Nussbaum, Wengé
ESTANTE SUSPENDIDA en chapa de madera en melamina antimancha y antiarañazos. Espesor 18 mm Color manzano, nogal, wengé

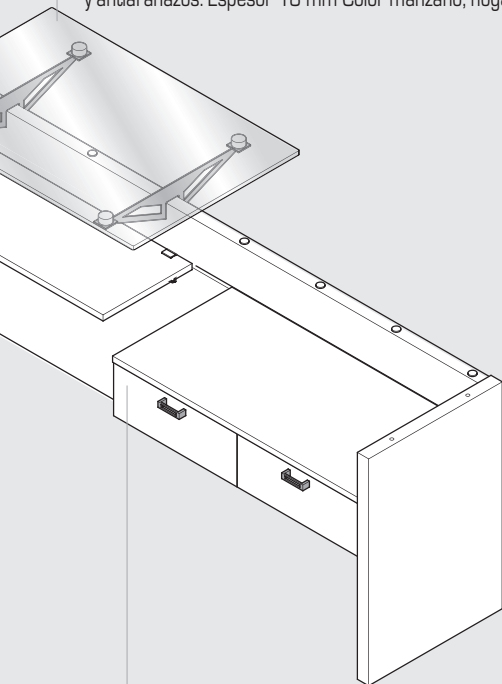

CASSETTIERA PENSILE in truciolare melaminico antimacchia, antigraffio spessore 18 mm colore melo, noce, wengé - interno cassetti in Pvc
SUSPENDED DRAWER UNIT in stainproof and antiscratch melamine chipboard thickness 18 mm colour apple wood, walnut, wengé internal drawers in Pvc
CAISSON SUSPENDU en bois aggloméré mélaminé anti-taches et anti-rayures Épaisseur 18 mm Coloris pommier, noyer, wengé - intérieur tiroir en PVC

CAISSON SUR ROULETTES Structure et façade de tiroir en bois aggloméré mélaminé anti-taches et anti-rayures, épaisseur 18 mm, dessus épaisseur 25 mm, Coloris pommier, noyer, wengé **Serrure** avec verrouillage simultané de tous les tiroirs
ROULETTE pivotante en ABS noir **poignée** en métal
ROLLCONTAINER Korpus u. **Schubladenfront**: u. aus kratzfeste bzw. Fleckenabweisender Melaminbeschichteter Spanplatte, 18 mm stark
Abdeckplatte 25 mm stark **Farbe**: Apfelbaum, Nussbaum, Wengé **Schloss**: serienmäßig zur gleichzeitiger Schließung v. alle Schubladen. **Rollen**, schwenkbar aus ABS, schwarz **Metall-Bügelgriff**
CAJONERA CON RUEDAS Estructura y Frontal cajón en chapa de melamina antimancha y antiarañazos. Espesor 18 mm **Estante** espesor 25 mm **Acabado** manzano, nogal, wengé **Cerradura** estandard con bloqueo de todos cajones. **Ruedas** en ABS negro giratorias **Tirador** en metal.

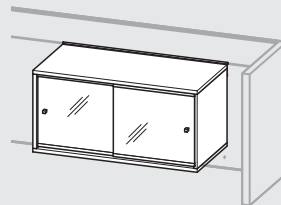
**MOBILE SERVIZIO PENSILE**

Struttura in truciolare melaminico antimacchia, antigraffio Spessore 18 mm Colore melo, noce, wengé
 Ante scorrevoli in vetro satinato temperato Spessore 6 mm

SUSPENDED MULTIPURPOSE CABINET

Structure in stainproof and antiscratch melamine chipboard Thickness 18 mm Colour apple wood, walnut, wengé
 Sliding doors in tempered satin glass Thickness 6 mm

CRÉDENCE SUSPENDUE

Structure en bois aggloméré mélaminé anti-taches et anti-rayures Épaisseur 18 mm Coloris pommier, noyer, wengé
 2 portes vitrées coulissantes

GLAS-SCHIEBETÜREN

Fleckenabweisender Melaminbeschichteter Spanplatte, 18 mm stark Farbe Apfelbaum, Nussbaum, Wengé
 2 Glas-Schiebetüren

ARMARIO SUSPENDIDO

Estructura en aglomerado de madera revestido de melamina resistente a manchas y al rayado Espesor 18 mm Color manzano, nogal, wengé
 2 puertas correderas en cristal temprado

SCHUBLADEN HÄNGENDES u. Abdeckplatte aus kratzfeste bzw. Fleckenabweisender Melaminbeschichteter Spanplatte, 18 mm stark
 Farbe Apfelbaum, Nussbaum, Wengé
 Schubladenzarge PVC,

CAJONERA SUSPENDIDA en aglomerado de madera revestido de melamina resistente a manchas y al rayado Espesor 18 mm Color manzano, nogal, wengé - Interior de cajón en PVC

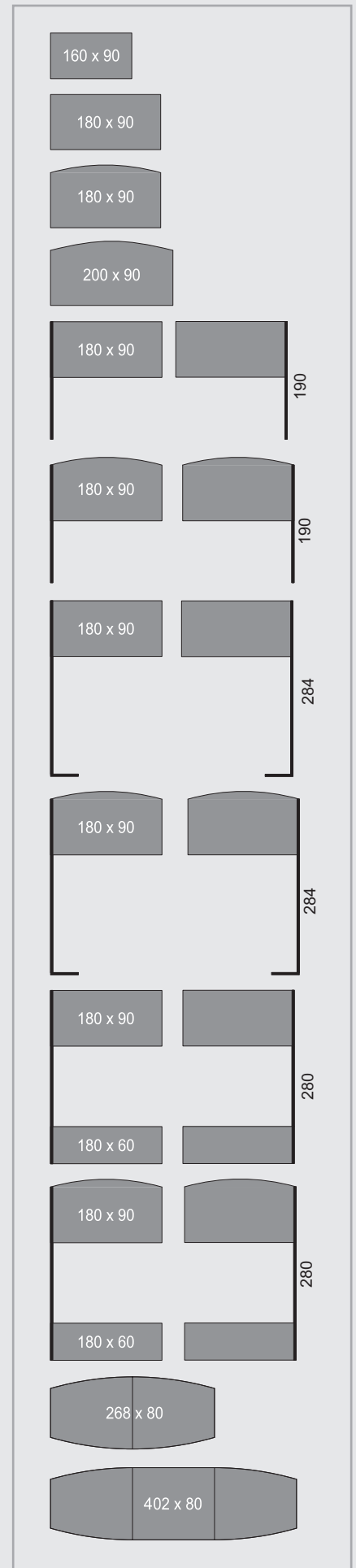

TAVOLI SCRIVANIA

Tables and desks

Tables et bureaux

Tische und Schreibtische

Mesas y escritorios

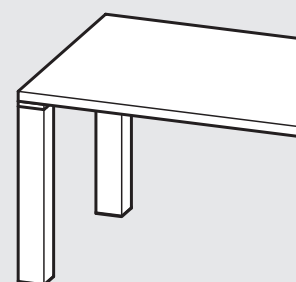
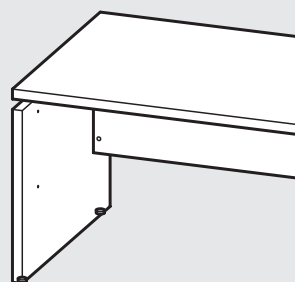

84,2 0,209 5 126.160. 034 365,57
035
027

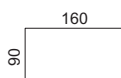
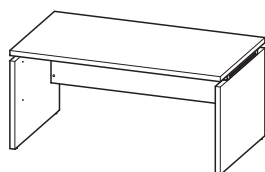

160 × 90 × H 73,5

90,2 0,224 5 126.180. 034 380,18
035
027

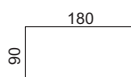
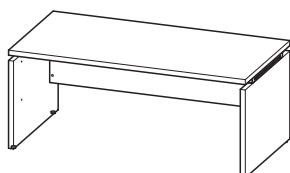

180 × 90 × H 73,5

76,5 0,183 3 126.182. 034 500,12
035
027

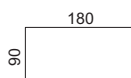
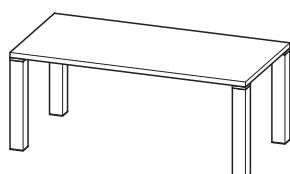

180 × 90 × H 73,5

SAGOMATA
Shaped desk
Conviviuu
Gefornt Tisch
Mesa perfilada

94,2 0,235 5 126.181. 034
035
027 **410,56**

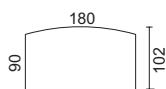
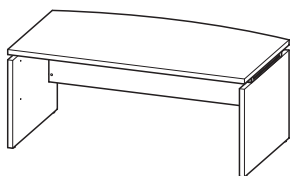

180 × 102 × H 73,5

SAGOMATA
Shaped desk
Conviviuu
Gefornt Tisch
Mesa perfilada

79,0 0,194 3 126.183. 034
035
027 **530,50**

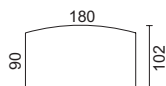
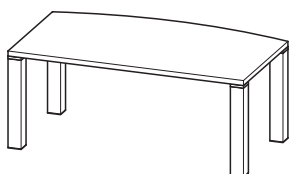

180 × 102 × H 73,5

SAGOMATA
Shaped desk
Conviviuu
Gefornt Tisch
Mesa perfilada

103,2 0,256 5 126.201. 034
035
027 **429,67**

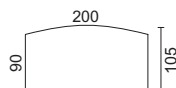
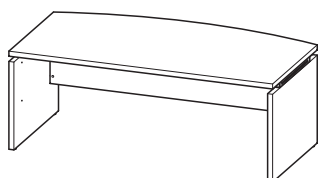

200 × 105 × H 73,5

SAGOMATA
Shaped desk
Conviviuu
Gefornt Tisch
Mesa perfilada

87,0 0,212 3 126.202. 034
035
027 **546,24**

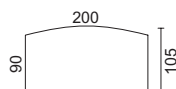
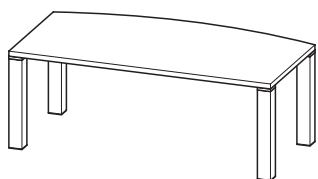

200 × 105 × H 73,5

ALLUNGO SCRIVANIA SU GAMBA METALLICA

Extension for desk on metal leg
 Extension bureau sur pied métallique
 Schreibtisch-Verlängerung auf Metall-Stützfuß
 Ala con pie metálico

20,8	0,057	3	126.211.	034 035 027	119,22
------	-------	---	----------	-------------------	--------

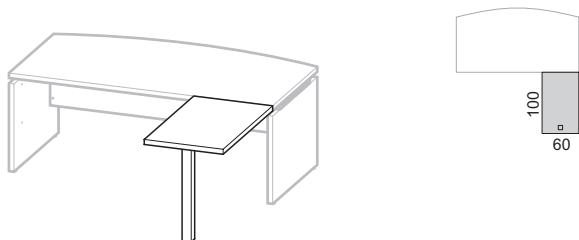

100 × 60 × H 73,5

TAVOLI SCRIVANIA CON MURETTO

Tables and desks with type wall
 Bureaux avec muret
 Schreibtische mit Wangenverlängerung
 Mesa con muro

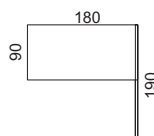
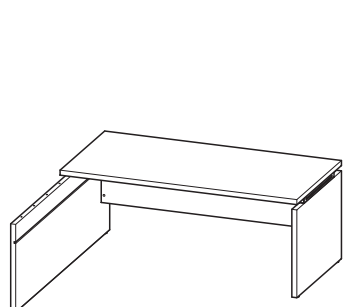
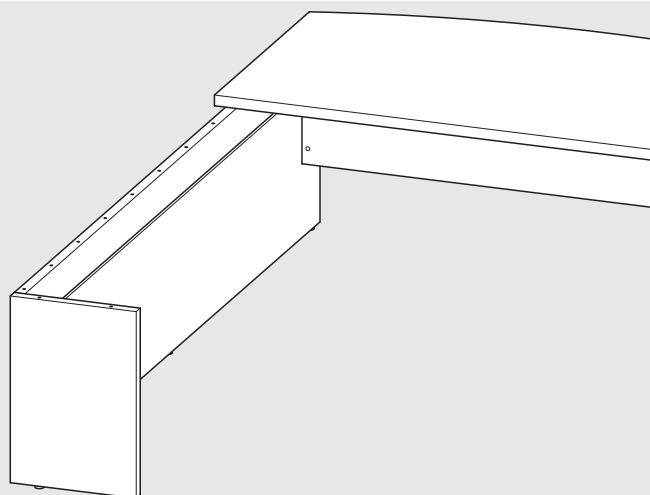

DX Right D Re Der	108,2	0,266	5	126.111.	034 035 027	527,51
--------------------------------------	-------	-------	---	----------	-------------------	--------

180 × 190 × H 73,5

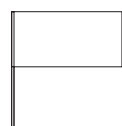

SX Left G Li Izq	108,2	0,266	5	126.112.	034 035 027	527,51
-------------------------------------	-------	-------	---	----------	-------------------	--------

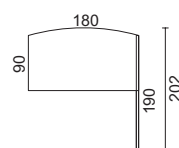
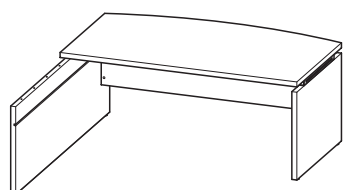

DX Right D Re Der	112,2	0,277	5	126.115.	034 035 027	557,89
--------------------------------------	-------	-------	---	----------	-------------------	--------

180 × 202 × H 73,5

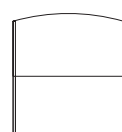

SX Left G Li Izq	112,2	0,277	5	126.116.	034 035 027	557,89
-------------------------------------	-------	-------	---	----------	-------------------	--------

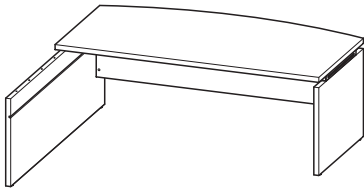

200 × 205 × H 73,5

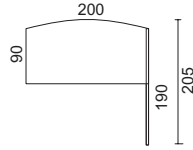

DX
Right
D
Re
Der

121,2 0,298 5 126.119. 034 577,00
035
027

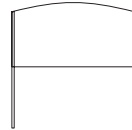

SX
Left
G
Li
Izq

121,2 0,298 5 126.120. 034 577,00
035
027

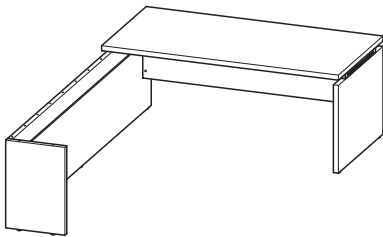

180 × 284 × H 73,5

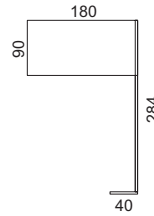

DX
Right
D
Re
Der

133,7 0,319 6 126.113. 034 662,49
035
027



SX
Left
G
Li
Izq

133,7 0,319 6 126.114. 034 662,49
035
027

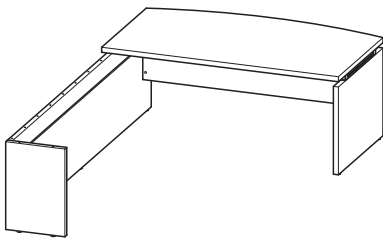

180 × 296 × H 73,5

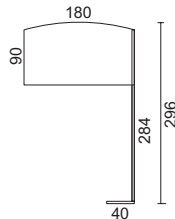

DX
Right
D
Re
Der

137,7 0,319 6 126.117. 034 692,87
035
027

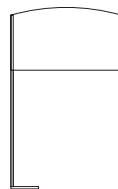

SX
Left
G
Li
Izq

137,7 0,319 6 126.118. 034 692,87
035
027

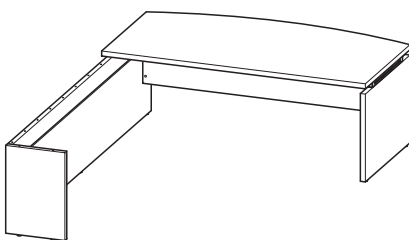

200 × 299 × H 73,5

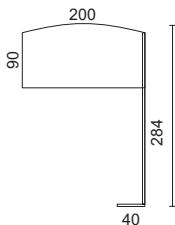

DX
Right
D
Re
Der

146,7 0,351 6 126.121. 034 711,98
035
027



SX
Left
G
Li
Izq

146,7 0,351 6 126.122. 034 711,98
035
027

COMPOSIZIONI "ISOLA" SCRIVANIE CON MURETTO

Desks compositions with type wall

Compositions île bureaux avec muret

Schreibtischinsel-Komposition mit Wangenverlängerung

Composición isla mesas con muro

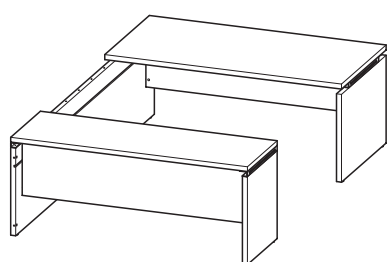
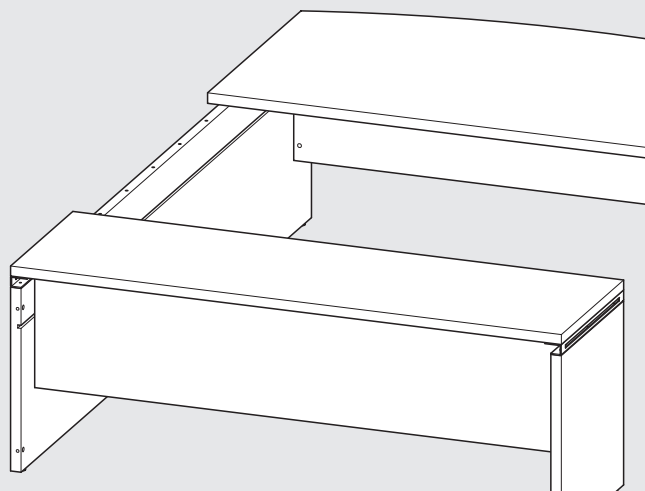

180 × 280 × H 73,5

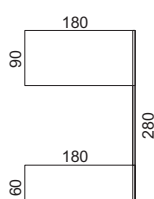

DX
Right
D
Re
Der

177,2 0,433 8 **126.123. 034**
035
027

881,81

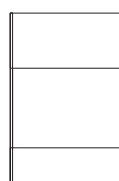

SX
Left
G
Li
Izq

177,2 0,433 8 **126.124. 034**
035
027

881,81

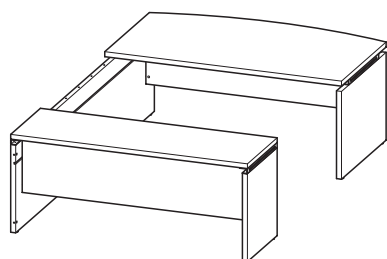

180 × 292 × H 73,5

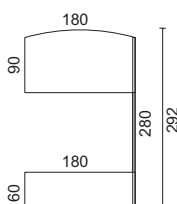

DX
Right
D
Re
Der

181,2 0,444 8 **126.125. 034**
035
027

912,19

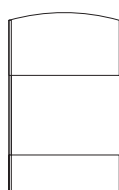

SX
Left
G
Li
Izq

181,2 0,444 8 **126.126. 034**
035
027

912,19

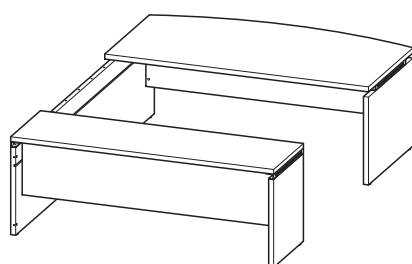

200 × 295 × H 73,5

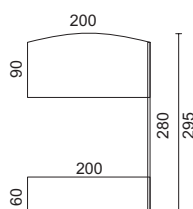

DX
Right
D
Re
Der

194,1 0,479 8 **126.127. 034**
035
027

942,55

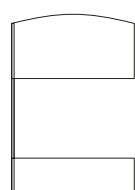

SX
Left
G
Li
Izq

194,1 0,479 8 **126.128. 034**
035
027

942,55

TAVOLI RIUNIONE

Meeting tables
 Tables de réunion
 Konferenztisch
 Mesas de reunión

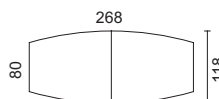
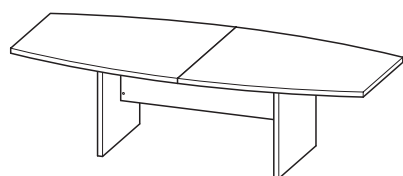
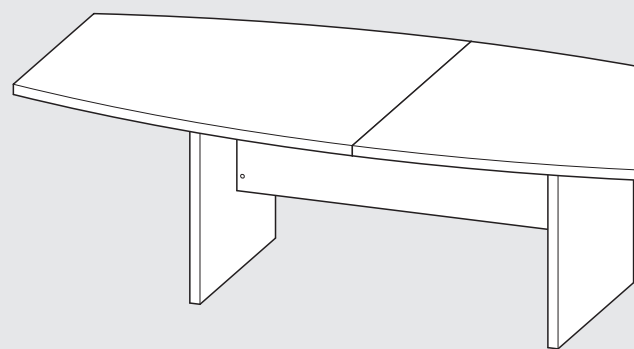

268 × 118 × H 73,5

125,6 0,276 7 **126.425. 034**
035
027 **490,39**

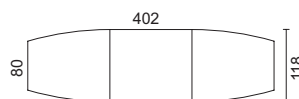
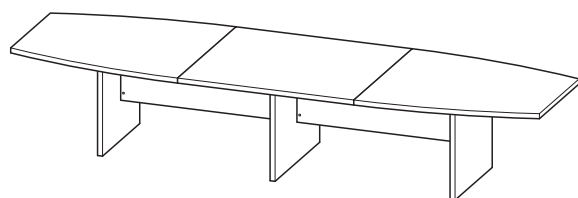

402 × 118 × H 73,5

195,7 0,433 12 **126.426. 034**
035
027 **749,07**

ALLUNGO PER TAVOLI RIUNIONE
 Extension for meeting tables
 Retour pour tables de réunion
 Konferenztische-verlängerung
 Extensión para mesas de reuniones

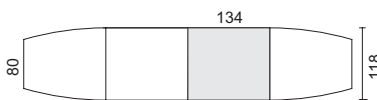
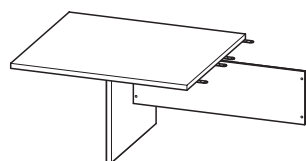

134 × 118 × H 73,5

70,1 0,157 5 **126.427. 034**
035
027 **258,68**

SU GAMBA METALLICA
 On metal leg
 Sur pied métallique
 Auf Metallfuß
 Con pata metálica

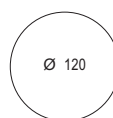

Ø 120 × H 73,5

63,5 0,204 3 **126.452. 055**
077
095 **289,18**

CASSETTIERE E MOBILETTI DI SERVIZIO SU RUOTE

Drawer units and multipurpose cabinets on castors
 Caissons et crédences sur roulettes
 Schubladenelemente und Beistellmöbel auf rollen
 Cajoneras y muebles de servicio con ruedas

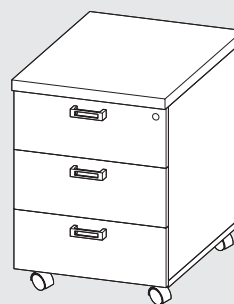

CASSETTIERA SU RUOTE / 3 CASSETTI

Drawer unit on castors / 3 drawers
 Caisson sur roulettes / 3 tiroirs
 Schublade-Rollcontainer / 3 Schubladen
 Cajonera con ruedas / 3 cajones



41,5 × 56 × H 57,5

28	0,160	1	226.613. 034	179,96
			035	
			027	

CASSETTIERA SU RUOTE / 1 CASSETTO + CLASSIFICATORE

Drawer unit on castors / 1 drawer + filing drawer
 Caisson sur roulettes / 1 tiroir + 1 tiroir pour dossiers suspendus
 Schublade-Rollcontainer / 1 Schublade u. + 1 Hangeregistratur-Auszug
 Cajonera con ruedas / 1 cajón + clasificador



41,5 × 56 × H 57,5

28	0,160	1	226.612. 034	200,20
			035	
			027	

MOBILE DI SERVIZIO SU RUOTE / 1 ANTA PIENA E 3 CASSETTI

Multipurpose cabinet on castors / 1 panelled door and 3 drawers
 Crédence sur roulettes / 1 porte pleine / 3 tiroirs
 Service-Möbel auf Rollen 1 volle Tür / 3 Schubladen
 Mueble auxiliar / 1 puerta batiente 3 cajones

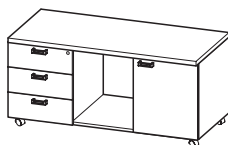

120 × 54 × H 57,5

47	0,394	1	226.228. 034	326,18
			035	
			027	

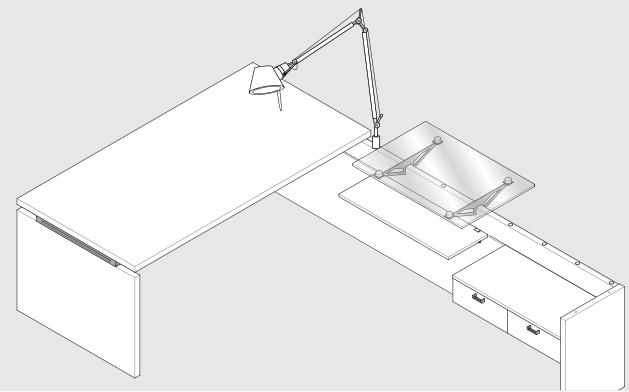

ACCESSORI PER MURETTO

Accessories for type wall

Accessoires pour muret

Wangenzubehör

Accesorios para muro

MENSOLA VETRO ACIDATO

Satin glass shelf
Top en verre
Geätzte Glasablage
Ménsula en cristal opaco

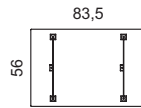
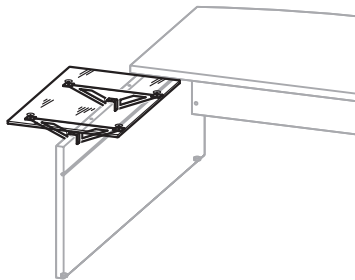

83,5 × 56 × H 1,2

20,2 0,035 2 126.215. 059 201,33

MENSOLA

Shelf
Étagère
Ablage
Estante

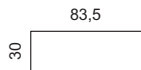
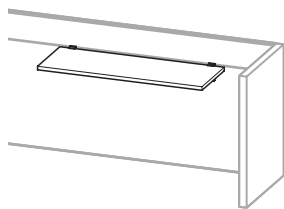

83,5 × 30 × H 1,8

3,5 0,011 1 226.871. 034 73,11
035
027

MOBILETTO SOSPESO / 2 CASSETTI

Hanging cabinet / 2 drawers
Petit meuble suspendu / 2 tiroirs
Oberschrank / 2 Schubladenelement
Mueble suspendido / 2 cajones

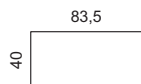
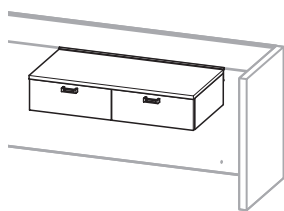

83,5 × 40 × H 17,5

20 0,066 1 226.602. 034 146,22
035
027

MOBILETTO SOSPESO / 2 ANTE VETRO SCORREVOLI

Hanging cabinet / 2 sliding glass doors
Crédence suspendue / 2 portes vitrées coulissantes
Hängendes Untersch., / 2 Glas-Schiebetüren
Mueble suspendido / 2 puertas correderas en cristal

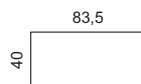
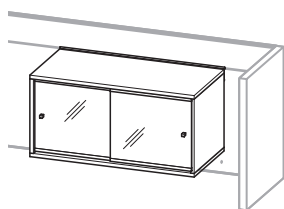

83,5 × 40 × H 41

23,5 0,146 1 226.225. 034 239,58
035
027

PORTA CPU

CPU holder
Support pour unité centrale
CPU-Träger
Porta ordenador

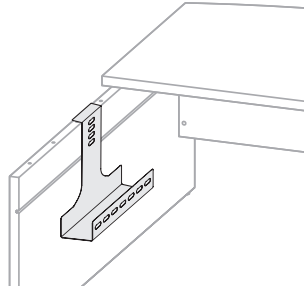

47 × 25 × H 49

5 0,071 1 226.921. 050 65,86

LAMPADA "TOLOMEO" DI ARTEMIDE

Lamp "Tolomeo" by Artemide
Lampe "Tolomeo" Artemide
"Tolomeo" Lampe von Artemide
Lámpara "Tolomeo" by Artemide

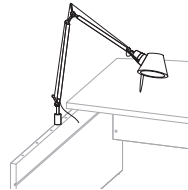

con supporto
with support
avec support
mit halterung
con soporte

3 0,043 1 227.945. 050 240,24



con base
with base
avec base
mit unterteil
con base

9 0,050 2 127.945. 050 380,84

VASCHETTA PORTA CARTE

Paper holder
Porte-papier
Papierablage
Porta papeles

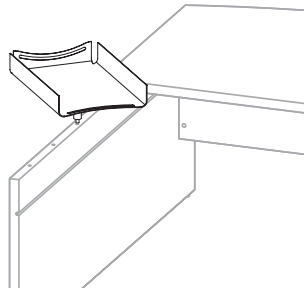

25 × 38 × H 6

2,5 0,011 1 227.946. 050 104,46

ACCESSORI

Accessories
Zubehör
Accesorios
Accessoires

MODESTY PANEL

Modesty panel
Voile de fond
Knieblende
Modesty panel

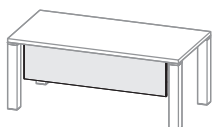

scrivania 180 5,60 0,028 1 126.295. 134 75,71
desk 180 135
bureau 180
schreibtisch 180 127
escritorio 180

scrivania 200 6,40 0,032 1 126.296. 134 83,28
desk 200 135
bureau 200
schreibtisch 200 127
escritorio 200

142 / 162 × 1,8 × H 38

MANIGLIA IN METALLO

Metal handle
Poignée en métal
Metall-Buegelgriff
Tirador en metal

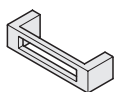

Passo mm 64 - Pitch mm 64 - Pas mm 64
64 mm Nabenabstand - Paso mm 64

7,1 × 2,2 × H 1,7

0,2 0,001 1 226.051. 000 5,63

SOTTOMANO IN PELLE

Leather desk pad
Sous-main en cuir noir
Leder-Schreibauflage
Bade en piel negra

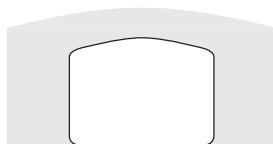

80 × 51,5 × H 0,33

3,5 0,01 1 290.926. 000 182,70

TAPPO PASSACAVI

Cable passage flap
Obturbateur passe-câbles
Abdeckung für Kabelkanal
Tapón pasacables



SPECIFICARE LA POSIZIONE DI APPLICAZIONE (A - B - C)
Specify the position of application (A - B - C)
Spécifier la position d'application (A - B - C)
Die Applikationsstellung bestimmen (A - B - C)
Especificar la posición de aplicación (A - B - C)

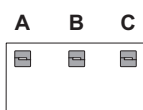

applicato
inserted
appliqué
Eingebaute
pegado

Ø 8

0,1 0,001 1 211. 903. 050 4,83

1 211. 904. 050 27,44

CANALIZZAZIONE VERTICALE

Vertical canalization
Canalisation verticale
Vertikaler Kanal
Canalización vertical



6 × 2,5 × H 64,5

0,9 0,001 1 290.918. 050 15,44

CARTELLA SOSPESA - 100 PZ.

File holder - 100 pcs.
Dossiers suspendus boîte de 100 pièces
Hängeregister mit Beschriftungsmöglichkeit-100 Stck. Packung
Carpeta suspendida - 100 pzas

33 cm 8 0,042 1 290.908. 000 158,34

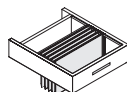
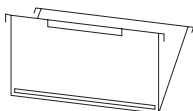

33 × 25

ANTA PIENA

In truciolare melaminico antimacchia e antigraffio Spessore 18 mm

Maniglia: in metallo

Serratura: di serie con chiave snodabile

PANELLED DOOR

In antiscratch and stainproof melamine chipboard thickness 18 mm

Handle: metal

Lock: standard with swivel key

PORTE PLEINE

En bois aggloméré mélaminé anti-taches et anti-rayures épaisseur 18 mm

Poignée: en métal

Serrure: de série avec clé articulée

HOLZDREHTUER AUS SPANHOLZPLATTEN

Mit kratzfester und Fleckenabweisender Melaminharzbeschichtung Stärke 18 mm

Griff: Metall

Schloss: serienmäßig mit verstellbarem Schlüssel

PUERTA LLENA

En chapa de madera antimancha y antiarañazos espesor 18 mm

Tirador: en metal

Cerradura: de serie con llave articulada

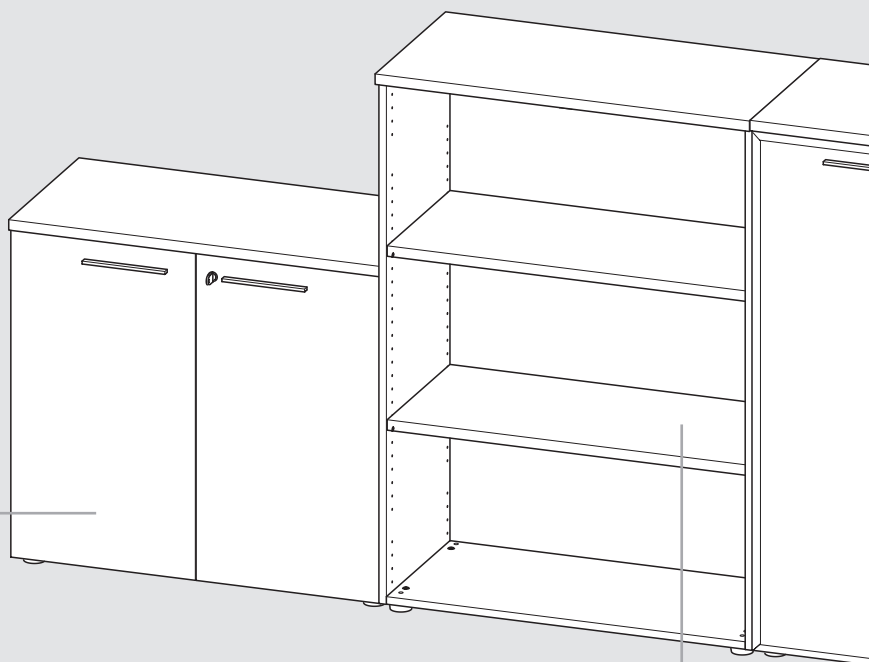

melo
apple wood
pommier
Apfelbaum
manzano

noce
walnut
noyer
Nussbaum
nogal

wengé

RIPIANO

In truciolare melaminico antimacchia e antigraffio Spessore 25 mm

SHELF

In antiscratch and stainproof melamine chipboard thickness 25 mm

ÉTAGÈRE

En aggloméré mélaminé anti-taches et anti-rayures épaisseur 25 mm

FACHBODEN

Aus Spanholzplatte mit kratzfester und Fleckenabweisender Melaminharzbeschichtung Stärke 25 mm

ESTANTE

En chapa de madera antimancha y antiarañazos espesor 25 mm

melo
apple wood
pommier
Apfelbaum
manzano

noce
walnut
noyer
Nussbaum
nogal

wengé



TOP STRUTTURALE

In truciolare melaminico antimacchia e antigraffio
Spessore 25 mm, bordo frontale in ABS 2 mm

STRUCTURAL TOP

In antiscratch and stainproof melamine chipboard
thickness 25 mm, frontal edge ABS 2 mm

DESSUS STRUCTUREL

En bois aggloméré mélaminé anti-taches et anti-rayures;
épaisseur 25 mm, chant avant en ABS 2 mm

OBERE ABDECKPLATTE

Aus Spanholzplatten mit kratzfester und Fleckenabweisender
Melaminharzbeschichtung Stärke 25 mm, 2 mm starke ABS-Frontkante

ESTANTE FIJO

En chapa de madera antimancha y antiarañazos
espesor 25 mm, perfil frontal ABS 2 mm



melo
apple wood
pommier
Apfelbaum
manzano



noce
walnut
noyer
Nussbaum
nogal



wengé

STRUTTURA

In truciolare melaminico antimacchia e antigraffio spessore 18 mm, **piedini**
regolabili in ABS

STRUCTURE

In antiscratch and stainproof melamine chipboard thickness 18 mm, ABS
adjustable **feet**

STRUCTURE

En bois aggloméré mélaminé anti-taches et anti-rayures épaisseur 18 mm,
 vérins de réglage en ABS

KORPUS

Aus Spanholzplatten mit kratzfester und Fleckenabweisender
Melaminharzbeschichtung Stärke 18 mm, höhenverstellbare **ABS-Füße**

ESTRUCTURA

En chapa de madera antimancha y antiarañazos espesor 18 mm, **pies** de
regulación en ABS

ANTE VETRO

Vetro temperato acidato spessore 4 mm su telaio in alluminio. **Maniglia:** in metallo. **Serratura:** di serie con chiave snodabile

GLASS DOORS

Glass tempered, acid-etched, thickness 4mm with aluminium frame. **Handle:** metal. **Lock:** standard with swivel key

PORTE VITRÉE

Vitrées trempé dépoli épaisseur 4 mm sur cadre en aluminium. **Poignée:** en métal. **Serrure:** de série avec clé articulée

GLASDREHTÜR AUS GEHÄRTETES

Gehärtetem geätztem Glas, Stärke 4 mm auf Aluminiumrahmen. **Griff:** Metall. **Schloss:** serienmäßig mit verstellbarem Schlüssel

PUERTA EN CRISTAL

Templado tratado al ácido de 4 mm de espesor con marco de aluminio. **Tirador:** en metal. **Cerradura:** de serie con llave articulada



CONTENITORI BASSI H 84

- Low cabinets H 84
- Armoires basses H 84
- Niedrige schränke H 84
- Contenedores bajos H 84

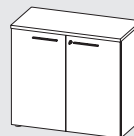

TOP STRUTTURALE
Structural top - Dessu structurel
Obere Abdeckplatte - Estante fijo

A GIORNO

- Open
- Ouverte
- Niedriges offenes Element
- Abierto



22,7 0,058 3 134.710. 034 98,07
035
027

45 × 43 × H 84

ANTA PIENA SERRATURA DI SERIE

- Panelled door Standard lock
- Porte pleine Serrure standard
- Mit Holztür Standardschloss
- Puerta llena Cerradura estandard



27,7 0,077 4 134.711. 034 132,95
035
027

45 × 45 × H 84

A GIORNO

- Open
- Ouverte
- Niedriges offenes Element
- Abierto



36,1 0,103 3 134.713. 034 134,16
035
027

90 × 43 × H 84

ANTE PIENE SERRATURA DI SERIE

- Panelled doors Standard lock
- Portes pleines Serrure standard
- Mit Holztüren Standardschloss
- Puertas llena Cerradura estandard



46,9 0,134 6 134.714. 034 207,63
035
027

90 × 45 × H 84

ANTE PIENE E FRIGO BAR SERRATURA DI SERIE

- Panelled doors and minibar Standard lock
- Portes pleines et minibar Serrure standard
- Mit Holztüren und minibar Standardschloss
- Puertas llena y minibar Cerradura estandard



67,2 0,133 6 134.716. 034 937,99
035
027

90 × 45 × H 84

A GIORNO / TOP L 135

Open / Top L 135
Ouvrte / Dessus L 135
Niedriges offenes Element / Abdeckplatte B 135
Abierto / Top L 135

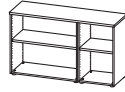

58,0 0,155 5 134.770. 034 218,33
035
027



135 × 43 × H 84

A GIORNO / TOP L 180

Open / Top L 180
Ouvrte / Dessus L 180
Niedriges offenes Element / Abdeckplatte B 180
Abierto / Top L 180

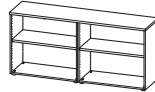

75,2 0,218 5 134.771. 034 254,34
035
027



180 × 43 × H 84

ANTE PIENE / TOP L 180

Panelled doors / Top L 180
Portes pleines / Dessus L 180
Mit Holztüren / Abdeckplatte B 180
Puertas llena / Top L 180

SERRATURA DI SERIE

Standard lock
Serrure standard
Standardschloss
Cerradura estandard

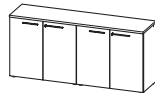

95,2 0,278 7 134.764. 034 401,28
035
027



180 × 45 × H 84

A GIORNO / TOP L 225

Open / Top L 225
Ouvrte / Dessus L 225
Niedriges offenes Element / Abdeckplatte B 225
Abierto / Top L 225



93,9 0,254 7 134.772. 034 340,98
035
027



225 × 43 × H 84

A GIORNO / TOP L 270

Open / Top L 270
Ouvrte / Dessus L 270
Niedriges offenes Element / Abdeckplatte B 270
Abierto / Top L 270

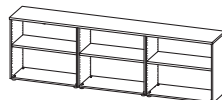

107,6 0,297 7 134.773. 034 375,19
035
027



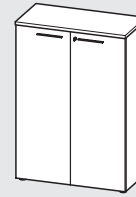

270 × 43 × H 84

CONTENITORI MEDI H 130,5
 Medium cabinets H 130,5
 Armoires mi-hautes H 130,5
 Mittelhohe schränke H 130,5
 Contenedores medios H 130,5

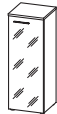
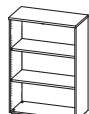

INFO TOP STRUTTURALE
 Structural top - Dessu structurel
 Obere Abdeckplatte - Estante fijo

<p>A GIORNO Open Ouverte Niedriges offenes Element Abierto</p>  <p>45 × 43 × H 130,5</p>	33,2	0,092	3	134.730. 034 035 027	132,47
<p>ANTA PIENA SERRATURA DI SERIE Panelled door standard lock Porte pleine serrure standard Mit Holztür standardschloss Puerta llena cerradura estandard</p>  <p>45 × 45 × H 130,5</p>	42,2	0,118	4	134.731. 034 035 027	176,03
<p>ANTA VETRO ACIDATO / TELAIO ALLUMINIO Satin glass door / aluminium frame Porte vitrée traitée à l'acide / encadrement aluminium Mit Gehaertete u. geätzte Glastür, Alurahmen Puerta en cristal opaco / perfil aluminio</p>  <p>SERRATURA NON APPLICABILE Not applicable lock Serrure pas applicable Nicht einsetzbar schloss Cerradura no aplicable</p> <p>45 × 45 × H 130,5</p>	42,9	0,148	4	134.718. 534 535 527	290,21
<p>ANTA VETRO FUME' Smoked glass door Porte vitrée fumé Mit Glastür verdunkelt Puerta en cristal fumé</p>  <p>SERRATURA NON APPLICABILE Not applicable lock Serrure pas applicable Nicht einsetzbar schloss Cerradura no aplicable</p> <p>45 × 45 × H 130,5</p>	42,2	0,139	5	134.732. 034 035 027	197,47
<p>A GIORNO Open Ouverte Niedriges offenes Element Abierto</p>  <p>90 × 43 × H 130,5</p>	52,3	0,168	3	134.733. 034 035 027	180,75

ANTE PIENE SERRATURA DI SERIE

Panelled doors standard lock
Portes pleines serrure standard
Mit holztüren standardschloss
Puertas llena cerradura estandard



71,1 0,213 6 134.734. 034 269,65
035
027

90 × 45 × H 130,5

ANTE VETRO ACIDATO / TELAIO ALLUMINIO

Satin glass doors / aluminium frame
Portes vitrées traitées à l'acide / encadrement aluminium
Mit Gehärtete u. geätzte Glastüren, Alurahmen
Puerta en cristal opaco / perfil aluminio

SERRATURA DI SERIE

standard lock
serrure standard
standardschloss
cerradura estandard



69,3 0,237 6 134.737. 034 497,87
035
027

90 × 45 × H 130,5

ANTE VETRO FUME' SERRATURA DI SERIE

Smoked glass doors standard lock
Portes vitrées fumé serrure standard
Mit Glastüren verdunkelt standardschloss
Puertas en cristal fumé cerradura estandard

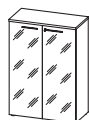

66,3 0,208 4 134.735. 034 310,91
035
027

90 × 45 × H 130,5

A GIORNO / TOP L 135

Open / Top L 135
Ouverte / Dessus L 135
Niedriges offenes Element / Abdeckplatte B 135
Abierto / Top L 135



84,7 0,254 5 134.806. 034 299,32
035
027



135 × 43 × H 130,5

A GIORNO / TOP L 180

Open / Top L 180
Ouverte / Dessus L 180
Niedriges offenes Element / Abdeckplatte B 180
Abierto / Top L 180

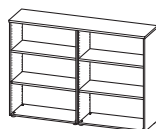

107,6 0,347 5 134.807. 034 347,52
035
027



180 × 43 × H 130,5

A GIORNO / TOP L 225

Open / Top L 225
Ouverte / Dessus L 225
Niedriges offenes Element / Abdeckplatte B 225
Abierto / Top L 225

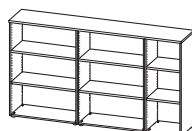

136,8 0,418 7 134.808. 034 468,56
035
027



225 × 43 × H 130,5



A GIORNO / TOP L 270

Open / Top L 270
Ouverte / Dessus L 270
Niedriges offenes Element / Abdeckplatte B 270
Abierto / Top L 270

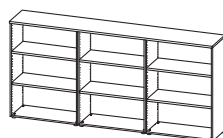

156,2 0,491 7 **134.809. 034** **514,96**
035
027



270 × 43 × H 130,5

CONTENITORI ALTI H 209

High cabinets H 209
Armoires hautes H 209
Hohe schränke H 209
Contenedores altos H 209

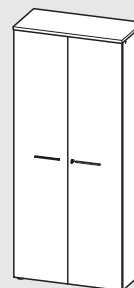

TOP STRUTTURALE

Structural top - Dessu structurel
Obere Abdeckplatte - Estante fijo

A GIORNO

Open
Ouverte
Niedriges offenes Element
Abierto



40,5 0,127 3 **134.754. 034** **187,99**
035
027

45 × 43 × H 209

ANTA PIENA SERRATURA DI SERIE

Panelled door Standard lock
Porte pleine Serrure standard
Mit Holztür Standardschloss
Puerta llena Cerradura estandard



55,5 0,169 4 **134.753. 034** **256,26**
035
027

45 × 45 × H 209

A GIORNO

Open
Ouverte
Niedriges offenes Element
Abierto



81,0 0,223 3 **134.759. 034** **255,15**
035
027

90 × 43 × H 209

A GIORNO +2 ANTE PIENE SERRATURA DI SERIE

Open cabinet +2 Panelled doors Standard lock
Ouverte +2 Portes pleines Serrure standard
Niedriges offenes Element +2 Holztüren Standardschloss
Abierto +2 Puertas llenas Cerradura estandard



91,0 0,253 4 **134.768. 034** **328,62**
035
027

90 × 45 × H 209



2+2 ANTE PIENE SERRATURA DI SERIE
 2+2 Panelled doors Standard lock
 2+2 Portes pleines Serrure standard
 2+2 Holztüren Standardschloss
 2+2 Puertas llenas Cerradura estandard

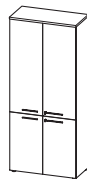

110,6 0,298 9 **134.755. 034** **417,52**
 035
 027

90 x 45 x H 209

2 ANTE + 2 ANTE VETRO ACIDATO / TELAIO ALLUMINIO SERRATURA DI SERIE

2 doors + 2 satin glass doors/
 aluminium frame - Standard lock
 2 Portes + 2 portes vitrées traitée à l'acide/
 encadrement aluminium - Serrure standard
 2 Holztüren + 2 Gehärtete Glastüren/
 rahmen aluminium - Standardschloss
 2 Puertas + 2 puertas en cristal opaco /
 perfil aluminio - Cerradura estandard



108,8 0,322 9 **134.779. 034** **645,74**
 035
 027

90 x 45 x H 209

2 ANTE + 2 ANTE VETRO FUME'

2 doors + 2 smoked glass doors
 2 Portes + 2 portes vitrées fumé
 2 Holztüren + 2 Glastüren verdunkelt
 2 Puertas + 2 puertas en cristal fumé

SERRATURA DI SERIE
 Standard lock
 Serrure standard
 Standardschloss
 Cerradura estandard

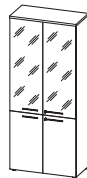

105,0 0,298 5 **134.760. 034** **458,78**
 035
 027

90 x 45 x H 209

ANTE PIENE SERRATURA DI SERIE

Panelled doors Standard lock
 Portes pleines Serrure standard
 Mit Holztüren Standardschloss
 Puertas llena Cerradura estandard

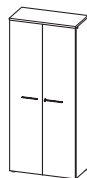

110,0 0,293 4 **134.758. 034** **386,04**
 035
 027

90 x 45 x H 209

APPENDI ABITI SERRATURA DI SERIE

Cabinet for coats Standard lock
 Vestiaire Serrure standard
 Gardarobenschrank Standardschloss
 Perchero Cerradura estandard



93,3 0,251 4 **134.763. 034** **363,20**
 035
 027

90 x 45 x H 209

RIPIANI PER CONTENITORI

Shelves for cabinets

Étagères pour armoires

Einlegeboden für schränke

Estantes para contenedores

PER CONTENITORE 45

For cabinet 45
Pour armoire 45
Für Schränke 45
Para contenedor 45



41,5 × 40 × H 2,5

4	0,007	1	234.831. 034	14,92
			035	
			027	

PER CONTENITORE 90

For cabinet 90
Pour armoire 90
Für Schränke 90
Para contenedor 90



86,5 × 40 × H 2,5

7	0,015	1	234.832. 034	23,00
			035	
			027	

ANTE PER CONTENITORI BASSI

H 84

Doors for low cabinets

H 84

Portes pour armoires basses

H 84

Niedrige Holztür

H 84

Puertas para contenedores bajos

H 84



1 ANTA PIENA SERRATURA DI SERIE

1 panelled door Standard lock
1 porte pleine Serrure standard
1 Holztür Standardschloss
1 Puerta llena Cerradura estandard



44,5 × 1,8 × H 78,5

5,1	0,020	2	134.811. 134	34,88
			135	
			127	

2 ANTE PIENE SERRATURA DI SERIE

2 Panelled doors Standard lock
2 Portes pleines Serrure standard
2 Holztüren Standardschloss
2 Puertas llenas Cerradura estandard

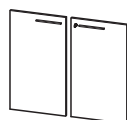

89 × 1,8 × H 78,5

10,1	0,031	3	134.812. 134	73,47
			135	
			127	

ANTE PER CONTENITORI MEDI H 130,5
 Doors for medium cabinets H 130,5
 Portes pour armoires mi-hautes H 130,5
 Mittelhöhe Türen H 130,5
 Puertas para contenedores medios H 130,5

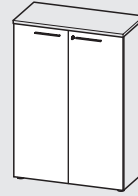

1 ANTA PIENA SERRATURA DI SERIE
 1 panelled door Standard lock
 1 porte pleine Serrure standard
 1 Holztür Standardschloss
 1 Puerta llena Cerradura estandard



9,1	0,027	2	134.813. 134	43,56
			135	
			127	

44,5 × 1,8 × H 124,5

1 ANTA VETRO ACIDATO / TELAIO ALLUMINIO
 1 Satin glass door / aluminium frame
 1 Porte vitrée traitée à l'acide / encadrement aluminium
 1 Gehaertete u. geätzte Glastür, Alurahmen
 1 Puerta en cristal opaco / perfil aluminio



9,6	0,056	2	134.815.050	157,74
-----	-------	---	-------------	---------------

SERRATURA NON APPLICABILE
 Not applicable lock
 Serrure pas applicable
 Nicht einsetzbar schloss
 Cerradura no aplicable



9,6	0,056	2	134.815. 150	157,74
-----	-------	---	--------------	---------------

44,5 × 2 × H 124,5

1 ANTA VETRO FUME'
 1 smoked glass door
 1 porte vitrée fumé
 1 Glastür verdunkelt
 1 Puerta en cristal fumé



SERRATURA NON APPLICABILE
 Not applicable lock
 Serrure pas applicable
 Nicht einsetzbar schloss
 Cerradura no aplicable

8,1	0,046	2	134.815. 200	65,00
-----	-------	---	--------------	--------------

44,5 × 0,4 × H 124,5

2 ANTE PIENE SERRATURA DI SERIE
 2 Panelled doors Standard lock
 2 Portes pleines Serrure standard
 2 Holztüren Standardschloss
 2 Puertas llenas Cerradura estandard

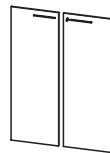

serratura superiore
 upper lock
 serrure en haut
 Schloss oben
 cerradura superior



18,2	0,046	3	134.814. 234	88,90
			235	
			227	

serratura inferiore
 lower lock
 serrure en bas
 Schloss unten
 cerradura abajo



18,2	0,046	3	134.814. 334	88,90
			335	
			327	

89 × 1,8 × H 124,5

2 ANTE VETRO ACIDATO / TELAIO ALLUMINIO SERRATURA DI SERIE
 2 Satin glass doors / aluminium frame - Standard lock
 2 Portes vitrées traitées à l'acide / encadrement aluminium
 Serrure standard
 2 Gehaertete Glastüren / rahmen aluminium
 Standardschloss
 2 Puertas en cristal opaco / perfil aluminio
 Cerradura estandard



serratura superiore
 upper lock
 serrure en haut
 Schloss oben
 cerradura superior



16,4	0,070	3	134.816. 250	317,12
------	-------	---	--------------	---------------

serratura inferiore
 lower lock
 serrure en bas
 Schloss unten
 cerradura abajo



16,4	0,070	3	134.816. 350	317,12
------	-------	---	--------------	---------------

89 × 2 × H 124,5

2 ANTE VETRO FUME' SERRATURA DI SERIE
 2 Smoked glass doors Standard lock
 2 Portes vitrées fumé Serrure standard
 2 Glastüren verdunkelt Standardschloss
 2 Puertas en cristal fumé Cerradura estandard

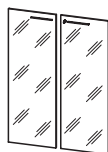

14,2 0,047 3 134.817. 100 130,16

44,5 × 1,8 × H 203

ANTE PER CONTENITORI ALTI H 209
 Doors for high cabinets H 209
 Portes pour armoires hautes H 209
 Holztüren für Hohe schränke H 209
 Puertas para contenedores altos H 209

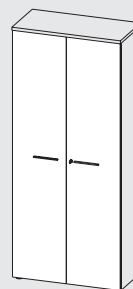

1 ANTA PIENA SERRATURA DI SERIE
 1 panelled door Standard lock
 1 porte pleine Serrure standard
 1 Holztür Standardschloss
 1 Puerta llena Cerradura estandard



15,1 0,043 2 134.819. 134 68,27
 135
 127

44,5 × 1,8 × H 203

2 ANTE PIENE SERRATURA DI SERIE
 2 Panelled doors Standard lock
 2 Portes pleines Serrure standard
 2 Holztüren Standardschloss
 2 Puertas llenas Cerradura estandard

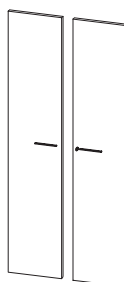

29,2 0,072 3 134.818. 134 130,89
 135
 127

89 × 1,8 × H 203



ACCESSORI PER CONTENITORE

Accessories for cabinet

Accessoires pour armoire

Schränken-Zubehör

Acesorios para armarios

PORTACARTELLE ESTRAIBILE PER CONTENITORE 90

Pull-out file holder for cabinet 90
Châssis télescopique pour armoire 90
Hängeregistraturauszug f. Schrank 90
Porta carpetas extraíble 90

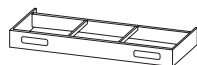

4 0,038 1 290.907. 000 107,43

82,5 x 35,5 x H 9

CARTELLA SOSPESA - 100 PZ.

File holder - 100 pcs.
Dossiers suspendus boîte de 100 pièces
Hängeregister mit Beschriftungsmöglichkeit-100 Stck. Packung
Carpetas suspendida - 100 pzas

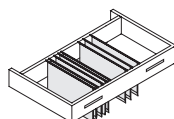

33 cm 8 0,042 1 290.908. 000 158,34

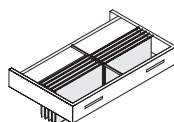
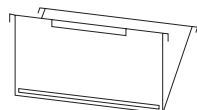

39 cm 9 0,042 1 290.909. 000 175,81

33 / 39 x 25

SERRATURA ANTA LEGNO

Lock for panelled door
Serrure porte bois
Schloss für volle Tür
Cerradura puerta madera

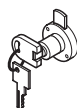

0,1 0,001 1 290.940. 000 9,56

serratura applicata
inserted lock
serrure appliqué
Schloss
cerradura insertada

290.941. 000 17,46

KIT MINI-BAR

Kit for Mini-bar
Kit réfrigérateur
Minibar-Schrankeinrichtung
Kit mini bar



25 0,132 2 121.100. 034
035
027 732,92

39 x 40 x H 53,5

MANIGLIA IN METALLO

Metal handle
Poignée en métal
Metall-Buegelgriff
Tirador en metal

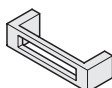

0,2 0,001 1 226.051. 000 5,63

Passo mm 64 - Pitch mm 64 - Pas mm 64
64 mm Nabenabstand - Paso mm 64

7,1 x 2,2 x H 1,7