



COLLEZIONE PRATIKO

Design: Giovanni Baccolini



Proponiamo solo alcune delle molteplici composizioni che potrete inventare utilizzando le pareti divisorie Della Rovere disponibili in diciotto colorazioni abbinabili. La semplicità del montaggio che identifica il nome dell'intera linea, consente davvero di decidere con estrema personalità le migliori soluzioni per creare postazioni di lavoro multiple, per ambientare reception o semplicemente ravvivare e rendere più funzionale il tuo posto di lavoro. Tutto prende forma agganciandosi alle pareti orizzontalmente e verticalmente, senza porre limiti alla propria immaginazione e mantenendo l'inconfondibile eleganza di un marchio più PRATIKO che mai!

We show you only few examples of the several available compositions created with the new partitions walls by Della Rovere, the solutions to satisfy your furnishing needs: multiple workstations, several available versions of receptions.

The main characteristics?... fast and easy mounting, 18 coupling colourings, vertical and horizontal system connection of accessories, make this new PRATIKO version giving no rise for doubts: your creation will be certainly a success!

PRATIKO

**TUTTO IL MONDO ATTORNO.
ALL THE WORLD AROUND.**

UN ESEMPIO DELLE POTENZIALITÀ APPLICATIVE DEI NOSTRI MODELLI CHE POSSONO ESSERE FACILMENTE RICONFIGURATI A SECONDA DEL TIPO DI GESTIONE OPERATIVA DESIDERATA. ADATTO A CREARE PUNTI DI ACCOGLIENZA E COMUNICAZIONE OPPURE SEMPLICI POSTAZIONI COMMERCIALI, PER FAR FRONTE ALL'ORGANIZZAZIONE DI QUALSIASI OPEN-SPACE.

AN EXAMPLE OF THE APPLICATION POTENTIAL OF OUR MODEL WHICH CAN BE EASILY REARRANGED DEPENDING ON THE TYPE OF OPERATIONS MANAGEMENT IN USE. PERFECT FOR CREATING RECEPTION AND COMMUNICATIONS AREAS OR JUST SIMPLE COMMERCIAL WORKSTATIONS TO MEET THE ORGANISATIONAL NEEDS OF ANY OPEN SPACE.



QUESTO TIPO DI SOLUZIONE GARANTISCE, AD OGNI OPERATORE, LA PRIVACY NECESSARIA PER REALIZZARE IN TRANQUILLITÀ IL PROPRIO LAVORO SENZA PERÒ COMPROMETTERE LO SCAMBIO DI SINERGIE FONDAMENTALE PER LA PRODUTTIVITÀ DI UN'IMPRESA.
 THIS TYPE OF SOLUTION ASSURES EACH WORKER THE PRIVACY NEEDED WITHOUT COMPROMISING THE EXCHANGE OF INFORMATION FUNDAMENTAL FOR A COMPANY'S PRODUCTIVITY.



DK014

DK012





PRATIKO



DP 056





PRATIKO

STRUTTURE MOBILI CHE ORGANIZZANO LO SPAZIO. POSTAZIONI DI LAVORO SINGOLE CHE TROVANO UN PIACEVOLE PUNTO D'INCONTRO NELLA ZONA MEETING.
MOVABLE STRUCTURES TO ORGANISE SPACE. INDIVIDUAL WORKSTATIONS WHICH ARE A PLEASANT MEETING PLACE IN A CONFERENCE AREA.



TRE DIVERSE NECESSITÀ RISOLTE DALL'AIUTO DI UNA SOLUZIONE CHE RENDE POSSIBILE ADATTARE IL LUOGO DI LAVORO AI FABBISOGNI OPERATIVI DEGLI UTENTI E DEI VISITATORI. TUTTO QUESTO SENZA TRASCURARE L'ELEMENTO CREATIVO DI MOVIMENTAZIONE DEGLI AMBIENTI. L'INSTALLAZIONE DEL SISTEMA È SEMPLICE E VELOCE, E LE MODIFICHE E GLI SPOSTAMENTI SUCCESSIVI SONO AGILI. LA COMPOSIZIONE FOTOGRAFATA NELLA FINITURA ACERO PUÒ ESSERE PROPOSTA IN MOLTEPLICI VARIANTI DI COLORE ED ABBINATA AL POLICARBONATO CURVATO CHE NE ESALTA IL RISULTATO FINALE.

THREE DIFFERENT NEEDS ARE MET WITH THE HELP OF A SOLUTION WHICH MAKES IT POSSIBLE TO ADAPT THE WORK PLACE TO THE OPERATIONAL NEEDS OF THE WORKERS AND THE VISITORS. ALL OF THIS WITHOUT NEGLECTING THE CREATIVE ELEMENT THAT ADDS MOVEMENT TO THE SETTINGS. THE SYSTEM IS EASILY AND QUICKLY INSTALLED, AND SUBSEQUENT MODIFICATIONS AND CHANGES IN POSITION ARE SIMPLE. THE COMPOSITIONS PHOTOGRAPHED IN MAPLE FINISH ARE AVAILABLE IN MANY COLOUR VARIATIONS AND CAN BE COMBINED WITH CURVED POLYCARBONATE WHICH ENHANCES THE FINAL RESULT.



IL RIGORE COMPOSITIVO DELLE GEOMETRIE, UTILIZZA MATERIALI D'AVANGUARDIA. IL COLORE GIOCA UN RUOLO IMPORTANTE NEL DETERMINARE IL CARATTERE DELLE COMPOSIZIONI, FORMA, COMFORT ED ELEGANZA COME FRUTTO DELL'ATTENZIONE POSTA NELLE SCELTE.
 THE COMPOSITIONAL SIMPLICITY OF THE GEOMETRY, THE USE OF AVANT-GARDE MATERIALS, THE USE OF COLOUR IN DETERMINING THE CHARACTER OF THE COMPOSITIONS. FORM, COMFORT AND ELEGANCE: THE RESULT OF CAREFULLY MADE CHOICES.

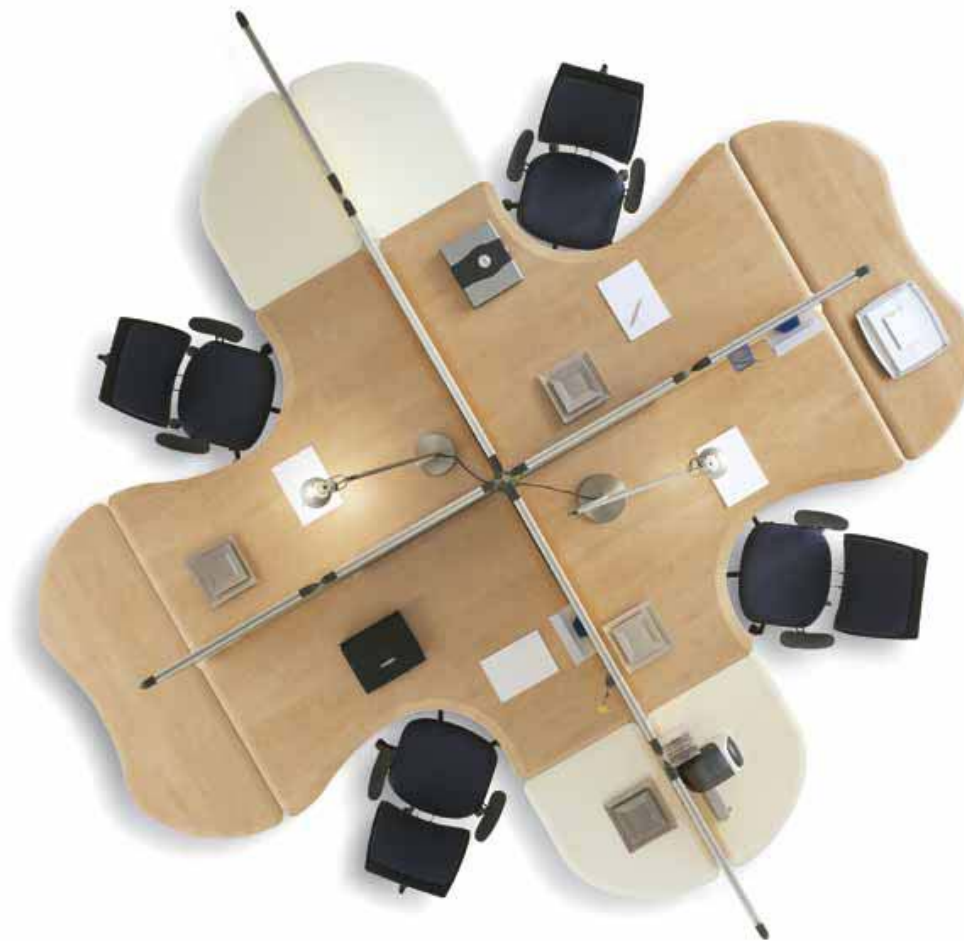

SISTEMI PRATIKO



PRATIKO



LE LINEE CURVE DEGLI ELEMENTI DIVISORI IN POLICARBONATO, RENDONO LA STRUTTURA DI QUESTA POSTAZIONE LEGGERA ED AL TEMPO STESSO MOLTO ELEGANTE.
THE CURVED LINES OF THE DIVIDING ELEMENTS IN POLYCARBONATE MAKE THE STRUCTURE OF THIS WORKSTATION LIGHT, YET EXTREMELY ELEGANT.



PRATIKO PARETI DIVISORE
PARTITIONS PRATIKO

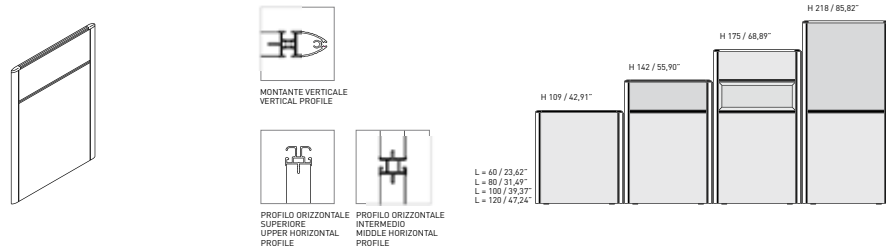

PRATIKO LIGHT PARETI DIVISORE DIRITTE E CURVE
LINEAR AND CURVED PARTITIONS PRATIKO LIGHT

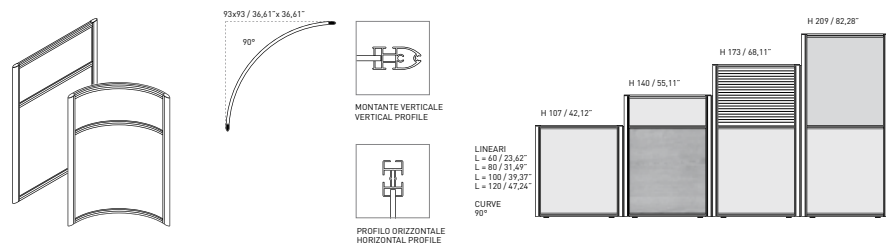

PARETI GOAL
GOAL PARTITIONS

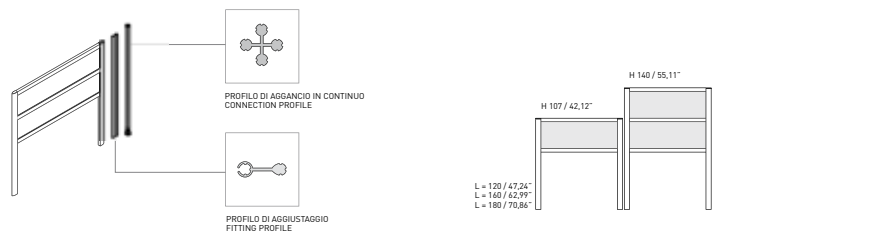

PRATIKO PARETI
PARTITIONS PRATIKO

PARETE CON ELEMENTO SUPERIORE IN VETRO
PARTITION WITH GLASS ELEMENT

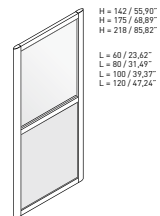

PARETE CON ELEMENTO PASSA CORRISPONDENZA
PASSAGEWAY FOR CORRESPONDANCE

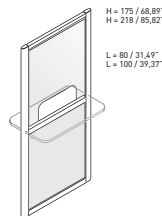

PARETE CON VETRO SERIGRAFATO
SILK-SCREENED TEMPERED GLASS PARTITION

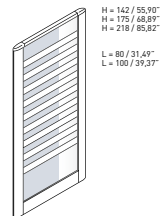

ACCESSORI
ACCESSORIES

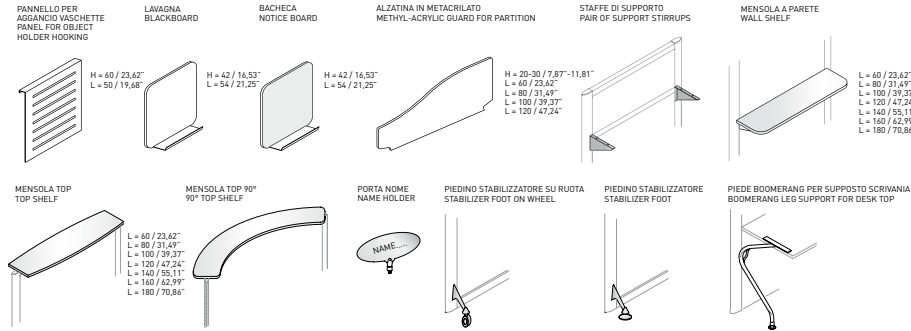

CANALIZZAZIONE
CABLE MANAGEMENT SYSTEM

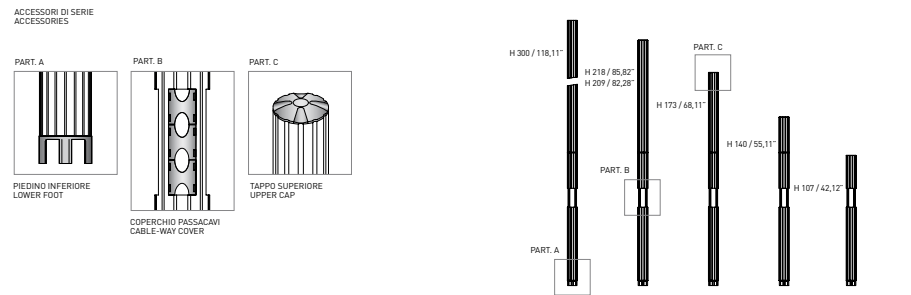

SNODI
JUNCTIONS

